

Piecewise Affine System Identification of a Hydraulic Wind Power Transfer System

Masoud Vaezi and Afshin Izadian, *Senior Member, IEEE*

Abstract—Hydraulic wind power transfer systems exhibit a highly nonlinear dynamic influenced by system actuator hysteresis and disturbances from wind speed and load torque. This paper presents a system identification approach to approximate such a nonlinear dynamic. Piecewise affine (PWA) models are obtained utilizing the averaged nonlinear models of hysteresis in a confined space. State-space representation of PWA models is obtained over the allocated operating point clusters. The experimental results demonstrate a close agreement with that of the simulated. The experimental results and simulation show more than 91% match.

Index Terms—Hydraulic wind power systems, nonlinear systems, piecewise affine (PWA) models, system identification.

I. INTRODUCTION

CONVENTIONALLY, wind turbines utilize gearboxes to transmit low-speed high-torque energy from blades to the generator. This system configuration can be improved as the cost of gearbox accounts for up to 34% of wind turbine. It also needs several overhauls and may need to be replaced several times in a 20-year lifespan of a wind turbine. Therefore, alternative replacements can be used to transfer the energy in the form of pressurized fluid such as hydraulic transmission. In this method, kinetic energy of the turbine is converted to a hydraulic pressurized fluid at the pump to transfer the energy to the generator on ground level [1], [2].

To reach the desired operating objectives from a hydraulic transmission system, the system needs to be controlled appropriately [3]. The speed control of hydraulic wind power systems is challenging, since it is a nonlinear system under random disturbances such as wind speed [4] and load torque. The nonlinearities in such a system are originated from nonlinear behavior of components, such as check valves, directional valves, and more importantly, the proportional valve. These nonlinearities will cause behavioral changes and variations in the system. Therefore, the speed control of the system would require an in-depth modeling. The controller's structure and performance depend on the accuracy of state variable approximation while the system is influenced by large input

variations in a wide operating range. Proper controllers can be designed using the linearized models [5], [6].

Implementing a flawless control loop for nonlinear systems with a wide range of operating points requires sufficient knowledge about the system dynamic by either mathematical modeling or system identification as well as information about all states. One of the promising ways to address those needs is to approximate the nonlinear system with piecewise affine (PWA) system. This method provides a number of linear models, each of which describes the nonlinear system in a specific operating region or cluster. A comprehensive model can be obtained utilizing a switching rule among the linearized models [7]–[11]. An estimation of the system state variables can also be carried out using a bank of linear models in multiple model adaptive estimation scheme [12], [13].

In addition, control of complex, nonlinear, and time-variant systems may need a bank of linearized models representing the system over a wide range of operating points. For instance, in multiple model adaptive controllers, a bank of candidate linearized models is designed to be used by the control structure [14]–[16]. A supervisory controller selects the most appropriate model or a linear combination of models to generate the control command. For each model, a suitable controller can be designed offline.

The precision of piecewise linear models selected in the bank of models directly influences the approximation, estimation, and control robustness [16]–[20]. The model bank can be obtained by: 1) piecewise linearization of nonlinear mathematical models [21] and 2) PWA system identification [22].

Considering the mentioned drawbacks of conventional wind turbines, several research projects are being conducted to improve the efficiency of hydraulic wind power transfer system (HWPTS) technology. There are several challenges regarding this new technology such as stability analysis, control system design, and efficiency analysis. Mathematical modeling is the primary approach to study the dynamic behavior of the system. This can be carried out by either utilizing the governing equations of the system component or system identification.

Nonlinear mathematical modeling of HWPTSs, using governing equations of system components, was introduced in the literature. References [23] and [24] provide the linear model of an HWPTS without the use of proportional valve. The nonlinear model of HWPTS including a proportional valve is derived in [25] using nonlinear state-space representation.

Manuscript received April 25, 2014; revised August 15, 2014 and November 3, 2014; accepted January 5, 2015. Manuscript received in final form January 23, 2015. Recommended by Associate Editor H. Wang.

The authors are with the Energy Systems and Power Electronics Laboratory, Purdue School of Engineering and Technology, Indianapolis, IN 46202 USA (e-mail: mvaezi@iupui.edu; aizadian@iupui.edu).

Color versions of one or more of the figures in this paper are available online at <http://ieeexplore.ieee.org>.

Digital Object Identifier 10.1109/TCST.2015.2398311

In [26] a pressure loss model is introduced and added to the HWPTS model to address the transmission efficiency. In addition, the more detailed nonlinear mathematical model of HWPTS is provided in [27] and [28] with experimental verification.

System identification method is another promising way to derive the mathematical model in various engineering fields [29]–[32]. Similarly, wind turbine's dynamics can be identified by utilizing system identification methods. Van der Veen *et al.* [33] proposed a methodology to obtain a nonlinear data-driven model of a wind turbine. The electromechanical components of wind turbines can be identified and modeled as well [34]. In addition, a closed-loop method is employed to identify wind turbine's model utilizing predictor-based system identification [35]. Finally, [36] applies two different system identification methods on a wind turbine to extract modal information at different operational conditions through experimental modal analysis in which input/output signals were measured and through operational modal analysis in which only output signals were measured.

In this paper, the nonlinear model of HWPTSs that operate on a wide range is linearized to construct the model bank. This enables an accurate estimation of a highly nonlinear system for more effective modeling and control techniques. This paper also identifies proper operating points to obtain accurate PWA model candidates. The experimental results are used to verify the modeling performance and validate the simulation results.

This paper is organized as follows. A hydraulic wind power system and its nonlinear components are discussed in Section II. Mathematical modeling of the hydraulic wind power system is introduced in Section III. Section IV is on PWA system identification. Finally, validations and the results are presented in Section V.

II. HYDRAULIC WIND POWER SYSTEM OPERATION

The HWPTS comprises various parts such as hydraulic pumps and motors, proportional valves, check valves, and pressure relief valves. This configuration uses a fixed displacement pump driven by the prime mover (wind turbine) and one or more fixed displacement hydraulic motors to convert the transmitted power. The hydraulic pump converts the mechanical input energy into pressurized fluid. Then, hydraulic hoses and steel pipes are used to transfer the harvested energy to the hydraulic motors [37].

A schematic of a hydraulic transmission system of wind energy is shown in Fig. 1. As the figure demonstrates, a fixed displacement pump is mechanically coupled with the wind turbine and supplies pressurized hydraulic fluid to two fixed displacement hydraulic motors: 1) main and 2) auxiliary. The hydraulic motors are coupled with electric generators to produce electric power in a central power generation unit. Since the wind turbine generates a large amount of torque at a relatively low angular velocity, a large displacement hydraulic pump is required to flow a large volume of the high-pressure hydraulics to transfer the power to the generators. The pump might also be equipped with a fixed internal speedup mechanism. Flexible high-pressure

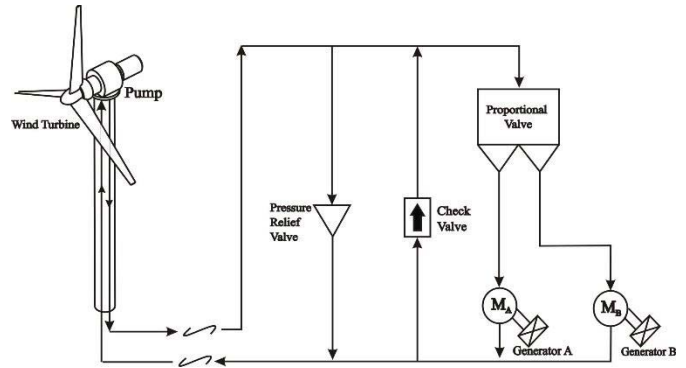

Fig. 1. Schematic of the high-pressure hydraulic power transfer system. The hydraulic pump is a distance from the central generation unit.

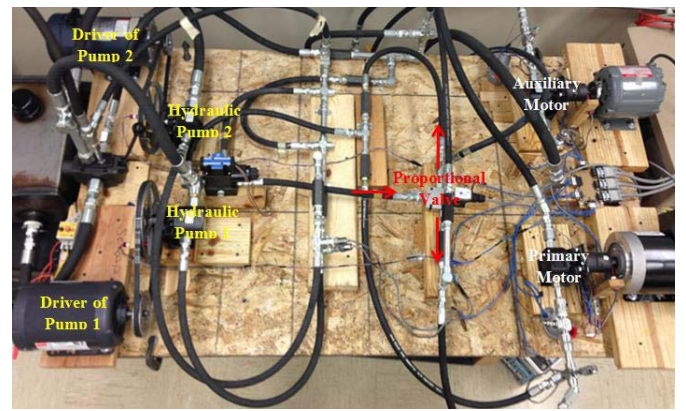

Fig. 2. Experimental setup of the HWPTS. Energy Systems and Power Electronics Laboratory, Purdue School of Engineering and Technology.

pipes/hoses connect the pump to the piping toward the central generation unit [2].

In this configuration, the pressure relief valves are considered to protect the system components from destructive impact of localized high-pressure fluids. In addition, check valves force the hydraulic flow to be unidirectional. Finally, the proportional valve distributes a controlled amount of flow to each hydraulic motor to be converted to the electrical power by the generators.

Consequently, the hydraulic wind power transmission systems receive pump speed and valve position as input variables. These two input variables generate a large operating area. Fig. 2 shows the experimental setup as a test bed in the Energy Systems and Power Electronics Laboratory. The test bed includes two electric motors to emulate wind turbines. One is a 3/4-hp dc motor run by a controllable rectifier, and one is a 2-hp ac motor controlled by an inverter. The generation side of the setup is equipped with two hydraulic motors, which can be separately controlled through a proportional valve. The valve is designed to switch 5 gallon/min of fluid instantaneously. Two induction generators are used to generate electric power from the wind transfer system. One induction motor of 1.5 hp and another one rated at 1/2-hp single phase. The electric load consists of a set of excitation capacitors and electric loads of steps 50 and 100 W. The parameters of the test bed are listed in Table I. The hydraulic circuit components have been

TABLE I
LIST OF EXPERIMENTAL PROTOTYPE PARAMETERS

Symbol	QUANTITY	Value	Unit
D_p	Pump displacement	0.722	in ³ /rev
D_{mA}	Primary motor displacement	0.241	in ³ /rev
D_{mB}	Auxiliary motor displacement	0.515	in ³ /rev
I_{mA}	Primary motor inertia	9.6	lb.in ²
I_{mB}	Auxiliary motor inertia	4.8	lb.in ²
B_{mA}	Primary motor damping	0.0141	lb.in/(rev/min)
B_{mB}	Auxiliary motor damping	0.0115	lb.in/(rev/min)
K_p	Pump leakage coefficient	0.046	in ³ /(psi.min)
K_{mA}	Primary motor leakage coefficient	0.06	in ³ /(psi.min)
K_{mB}	Auxiliary motor leakage coefficient	0.01	in ³ /(psi.min)
ν	Fluid viscosity	1.105	in ² /s
β	Fluid bulk modulus	183695	psi
ρ	Fluid density	0.0305	lbm/in ³

designed according to the fluid power principles. The system parameters such as damping, inertia, and leakage coefficients have been obtained through standard experiments on the setup after the system assembly. To record the system response, the prototype was forced to a wide range of operating points. This test bed was used to record data and validate the proposed mathematical models.

The next section introduces the governing equations of the hydraulic circuit.

III. MATHEMATICAL MODELING AND PROBLEM DEFINITION

The state-space representation of the hydraulic wind power system can be derived by considering the integrated configuration of the hydraulic components, such as pumps, proportional valves, and check valves. The nonlinear model of hydraulic circuit components [38], [39] and the nonlinear state-space representation of the hydraulic wind energy transfer are introduced in [23]–[28]. Considering dynamics of each hydraulic component, governing equations of flow and torque are derived. Those equations are used to represent the hydraulic transmission system in the form of nonlinear state-space equations. The representation of the system model with energy-storing state variables defined in vector x can be obtained as follows:

$$x = [P_p \quad P_{mA} \quad P_{mB} \quad \omega_{mA} \quad \omega_{mB}]^T \quad (1)$$

where the P_p is the pump pressure, P_{mA} is the main motor inlet pressure, P_{mB} is the auxiliary motor inlet pressure, ω_{mA} is the main motor, and ω_{mB} is the auxiliary motor speed. The input vector is defined as $U = [h_i \quad \omega_p]^T$ with h_i being the valve position and ω_p being the pump speed.

Nonlinear state-space model of the system is represented as

$$\begin{cases} \dot{x} = f(x) + g(x)U \\ y = h(x) \end{cases} \quad (2)$$

where the functions $f(x)$ and $g(x)$ are defined as follows [27]:

$$f(x) = \begin{bmatrix} \frac{\beta}{V_1} \left\{ -K_p P_p - \left(C_D A_{\max} \sqrt{\frac{2(P_p - P_{mB})}{\rho}} \right) \right\} \\ \frac{\beta}{V_2} \left\{ -D_{mA} \omega_A - K_{mA} P_{mA} \right\} \\ \frac{\beta}{V_3} \left\{ \left(C_D A_{\max} \sqrt{\frac{2(P_p - P_{mB})}{\rho}} \right) - D_{mB} \omega_B - K_{mB} P_{mB} \right\} \\ D_{mA} P_{mA} - B_{mA} \omega_{mA} - T_{ImA} \\ D_{mB} P_{mB} - B_{mB} \omega_{mB} - T_{ImB} \end{bmatrix} \quad (3)$$

$$g(x) = \begin{bmatrix} \frac{\beta}{V_1} \left\{ - \left(C_D \frac{A_{\max}}{h_{\max}} \sqrt{\frac{2(P_p - P_{mA})}{\rho}} \right) + \left(C_D \frac{A_{\max}}{h_{\max}} \sqrt{\frac{2(P_p - P_{mB})}{\rho}} \right) \right\} D_p \\ \frac{\beta}{V_2} \left(C_D \frac{A_{\max}}{h_{\max}} \sqrt{\frac{2(P_p - P_{mA})}{\rho}} \right) \\ \frac{\beta}{V_3} \left(C_D \frac{A_{\max}}{h_{\max}} \sqrt{\frac{2(P_p - P_{mB})}{\rho}} \right) \\ 0 \\ 0 \end{bmatrix} \quad (4)$$

Table I defines some symbols used in (3) and (4). Other symbols such as C_D , V , A_{\max} , and h_{\max} are discharge coefficient, fluid volume, outlet maximum surface, and spool maximum traveling, respectively.

As it can be observed from these equations, the model is highly nonlinear as a result of nonlinear components such as proportional valve. The proportional valve consists of one inlet and two outlet orifices and a spool that changes the flow passage area of the outlet orifices. The fluid enters the valve, and based on the position of spool, the flow is distributed between two outlets: 1) main and 2) auxiliary. The spool is displaced by applying current to its coil. The spool-coil valve control mechanism shows a large amount of hysteresis. Since the generator runs under electric load at synchronous speed, a constant speed of the hydraulic motor coupled with the generator is required to be maintained. However, hydraulic wind power systems are susceptible to intermittent wind speed and range of control commands (to proportional valve). For maintaining the flow rate specifically for the main motor, the proportional valve must adjust the spool displacement to compensate for disturbances. Wind speed variation changes the pump speed since it is connected to the turbine. Consequently, the amount of flow enters to the valve inlet varies. The variation of inlet flow affects the outlet flow so that the valve has to adjust the orifice to compensate for this disturbance. Hence, the rotational speed of motor can be controlled by utilizing a proportional valve. As mentioned earlier, operation of such a valve imposes nonlinearities in the system dynamics.

For the purpose of system analysis or a desired state control, a well-developed PWA model can be obtained and utilized. However, this requires that the linearized system represents

the nonlinear behavior of the system with a limited error on a large domain [40]. These types of nonlinear systems with a wide range of operating points are usually represented using multiple linear models for the whole system.

The technique used in this paper is to identify a local linear model for desired operating points. PWA system is therefore developed to cover the entire operating conditions. Each model should satisfactorily describe the plant in a specific domain. Each linear model will have an effective range, in which the system generates minimum deviation from the original plant. Out of this domain, the model's performance is reduced, hence a new plant with shifted operating conditions is required. The number of models in PWA systems highly affects the stability of the modeling and control as well as the amount of computations. This variable is often determined by the range of disturbances on the system.

IV. PIECEWISE AFFINE SYSTEM IDENTIFICATION

PWA systems are those whose state and input space is partitioned into a finite number of nonoverlapping convex polyhedral regions and whose individual subsystem in the different regions is linear or affine [41]–[43]. If the subsystem in each region displays an ARX (autoregressive systems with exogenous inputs) type of input output characteristics, then the system is called PWA ARX (PWARX) system [42], [43]. A growing interest in the study of PWA systems has been witnessed over the past decades because they are equivalent to several classes of hybrid models [44]. Thus, they can be used to obtain hybrid models from data. Typical examples of hybrid systems include manufacturing systems, telecommunication networks, traffic control systems, digital circuits, and logistic systems [45]. Another advantage of PWA models is that they can be used to approximate nonlinear dynamical systems by switching among several linear/affine models, depending on the operating regions [17]. Therefore, they can be used for a simpler controller design of nonlinear system—linear controllers for the linear subsystems can be first designed according to any of the well-known linear control synthesis methods. Then, based on the operating region of the nonlinear system, the controllers would switch from one to another.

A switching system in regression form can be described [46] as follows:

$$y_k = \varphi_k' \theta_{\sigma(k)} \quad (5)$$

where $\varphi_k \in \mathbb{R}^d$ is the regression vector, $(\cdot)'$ denotes transpose, $y_k \in \mathbb{R}$ is the output, $\sigma(k) \in \{1, \dots, s\}$ is the discrete mode, and s is the number of subsystems. $\theta_i \in \mathbb{R}^d$, $i = 1, \dots, s$, are the parameter vectors defining each subsystem.

The regression vector φ_k could, for instance, be any function of the past inputs and outputs. In the following, the focus will be on systems (5), where φ_k is formed:

$$\varphi_k = [y_{k-1} \dots y_{k-n_a} u'_{k-1} \dots u'_{k-n_b} 1]' \quad (6)$$

and $u_k \in \mathbb{R}^p$ is the input to the system. Such systems represent a subclass of the PWA systems in state-space form, and can be easily transformed into that form by defining the state vector as

$$x_k = [y_{k-1} \dots y_{k-n_a} u'_{k-1} \dots u'_{k-n_b}]'. \quad (7)$$

The last entry of φ_k is set equal to 1 in order to allow for a constant term in (5). If the constant 1 is omitted in (6), φ_k coincides with x_k , and the system becomes piecewise linear. In the following, the vector x_k will be referred to as the *standard* regression vector, and φ_k will be called the *extended* regression vector, since it can be written as $\varphi_k = [x_k' \ 1]'$. As for the systems in state-space form, the evolution of the discrete mode σ_k can be described in a variety of ways. In PWARX systems, the switching mechanism is determined by a polyhedral partition of the set $\chi \subseteq \mathbb{R}^n$, where (5) is valid. The discrete mode $\sigma(k)$ can be defined as

$$\sigma(k) = i \text{ if } x_k \in \chi_i, \quad i = 1, \dots, s \quad (8)$$

where $\{\chi_i\}_{i=1}^s$ is a complete partition of the regressor set χ , and each region χ_i is a convex polyhedron represented as follows:

$$\chi_i = \{x \in \mathbb{R}^n | \overline{H}_i x + g_i \leq 0\} \quad (9)$$

with $\overline{H}_i \in \mathbb{R}^{q_i \times n}$ and $g_i \in \mathbb{R}^{q_i}$, $i = 1, \dots, s$. By letting $H_i = [\overline{H}_i \ g_i]$, $i = 1, \dots, s$, and by introducing the PWA map, $f: \chi \rightarrow \mathbb{R}$ can be written as

$$f(x) = \begin{cases} \varphi_k' \theta_1 & \text{if } H_1 \varphi \leq 0, \\ \vdots & \vdots \\ \varphi_k' \theta_s & \text{if } H_s \varphi \leq 0. \end{cases} \quad \varphi = [x' \ 1]' \quad (10)$$

Equation (5) can be alternatively rewritten as follows:

$$y_k = f(x_k). \quad (11)$$

PWARX systems defined by (7), (10), and (11) can be considered as a collection of ARX systems connected by switches that are determined by a polyhedral partition of the regressor set.

PWA system identification concerns obtaining a PWA model of a system from the experimental data. PWA models represent an attractive model structure for identification purposes, since they are the simplest extension of linear models but can nevertheless describe nonlinear processes with arbitrary accuracy. PWA models are also capable of handling hybrid phenomena. Given the equivalence between PWA systems and several classes of hybrid, PWA identification techniques can be used to obtain hybrid models.

PWARX models are suitable for input–output data analysis, since they provide an input–output description of PWA systems. Consider a collection D data points out of N data points from the real system as follows:

$$D = \{(y_k, x_k), \quad k = 1, \dots, N\} \quad (12)$$

where $y_k \in \mathbb{R}$ is the *measured* output of the system and $x_k \in \mathbb{R}^n$ is the regression vector (7) for fixed orders n_a and n_b . A PWARX model is defined as follows:

$$y_k = f(x_k) + \varepsilon_k \quad (13)$$

where $\varepsilon_k \in \mathbb{R}$ is an error term and f is the PWA map (10).

The considered identification problem consists in finding the PWARX model that best matches the given data according to a specified fitting criterion. It involves the estimation of the following [46].

- 1) *Segmentation*:
 - a) the number of discrete modes s ;
 - b) the coefficients $H_i = 1, \dots, s$, of the hyperplanes defining the partition of the regressor set.
- 2) *Regression*:
 - a) the order of submodels, n_a and n_b ;
 - b) the parameters $\theta_i = 1, \dots, s$, of the affine submodels.

This issue also underlies a classification problem such that each data point is associated to one region and to the corresponding submodel. The simultaneous optimal estimation of all the above-mentioned quantities is hard and a computationally intractable problem. To the best of our knowledge, no satisfactory formulation in the form of a single optimization problem has been provided. One of the main difficulties is the choice of the number of discrete modes s . For instance, if a perfect fit is attained by $s = N$, it means one submodel is required per data point, which is clearly an inadequate solution. Constraints on s must hence be introduced to keep the number of submodels minimal and to avoid overfit. Heuristic and suboptimal approaches that are applicable, or at least related to the identification of PWARX models, have been proposed in the literature. Most of these approaches either assume a fixed s or adjust s iteratively (e.g., by adding one submodel at a time) to improve the fit [46].

V. HYDRAULIC WIND POWER SYSTEM IDENTIFICATION AND RESULTS

Considering various disturbances in the nonlinear model of hydraulic wind power system, operating point regions of such a system are remarkably wide. Therefore, describing the whole system linearly requires multiple linear models. As mentioned earlier, one can linearize the nonlinear mathematical model in different operating points to obtain the linear models. However, this method requires enough knowledge about the best operating points of the model, which is really challenging for a wide range of operating systems such as hydraulic wind power systems [6]. Another promising method in control system applications is PWA system identification. This approach searches for the best linear regions as well as estimation of model parameters, which advances the linear modeling of hydraulic wind power system.

To begin with the piecewise system identification approach, the operating points of the system must be determined. Different inputs to the system specify different operating points [47]. Thus, the range of each input variation is important. In the HWPTSs, the wind speed as an input is a highly varying parameter. To compensate for this variation, the control system adjusts the valve position to maintain a constant generator speed under wind speed and electric load variations. In our experimental setup, wind speed as one of the factors to determine the operating points varies from 200 to 1000 r/min. The other input, valve position, is directly related to the applied voltage, which ranges from 1.2 to 3.8 V. Each combination of these values would result in a different operating point. However, a partial group of these operating points can be included in the domain of a single linear model.

The mathematical model shows a system with five state variables and two inputs. One of the inputs is determined by wind speed, and the other is to maintain a fixed speed generator. Therefore, the output of the system is selected to be the generator speed.

Therefore, the problem of a PWA system identification for a five-state two-input hydraulic wind power system reduces to a multi-input single-output system identification, which is also graphically representable.

A. Hysteresis Compensation on Data Recording

As mentioned earlier, the proportional valve consists of one inlet and two outlet orifices and a spool that changes the flow passage area of the outlet orifices. The governing equation of flow rate for each outlet is obtained in (14), which relates the pressure differential across an orifice and the passage area to the flow rate. Flow rate passing an orifice is obtained as

$$Q = C_D A \sqrt{\frac{2\Delta P}{\rho}} \quad (14)$$

where A is the orifice area, which is determined by applied voltage, and ΔP is the pressure differential across the orifice. C_D and ρ are the discharge coefficient and the fluid density, respectively.

In the proportional valve, the hysteresis band is the widest separation observed on the spool displacement when the coil current is uniformly increasing from when it is uniformly decreasing. In other words, hysteresis is the difference between the valve position on the upstroke and its position on the down stroke at any given input signal. To analyze this nonlinearity, steady-state response of the system in all operating points is experimentally derived for both increasing valve voltage and decreasing valve voltage.

In the first experiment, at different pump speeds, the proportional valve is gradually opening to speed up the primary hydraulic motor. In the second experiment, the proportional valve is gradually closing to slow down the primary hydraulic motor. During this process, the primary hydraulic motor's angular velocity is being monitored along with the valve's applied voltage. Analyzing the motor speed and comparing with valve voltage resulted in two separate velocity envelopes suggesting the existence of a hysteresis. Fig. 3 shows the behavior of the system in each case. In addition, the normalized difference between surfaces in Fig. 3 is shown in Fig. 4.

To compensate for this multivalued nonlinearity, an averaging method can be utilized. An average of those two surfaces (shown in Fig. 3) can provide more reliable data for system identification. This averaged surface is shown in Fig. 5.

B. Segmentation

In a practical sense, finding a balance between the number of model partitions and the overall accuracy of the estimation is of interest. To explore this relationship, different methods of partitioning are introduced, such as average [48], z -score [49], and k -means [50]. The average method considers all observed

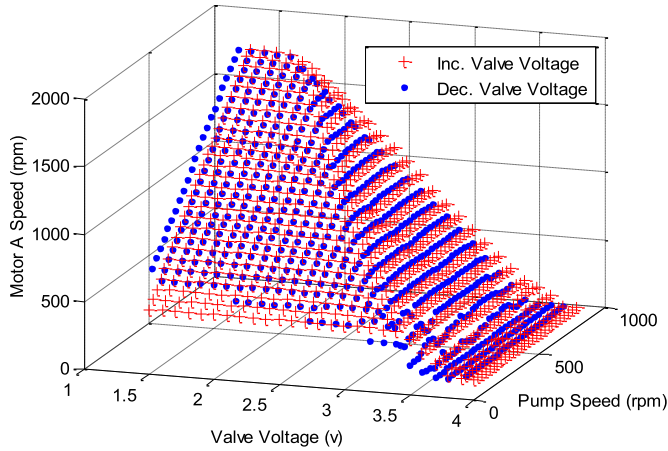

Fig. 3. Experimental steady-state system response in all operating points for increasing valve voltage and decreasing valve voltage (2187 data points).

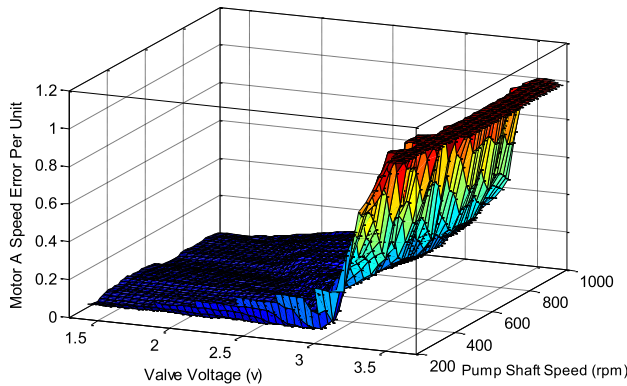

Fig. 4. Normalized difference between increasing valve system response and decreasing valve system response.

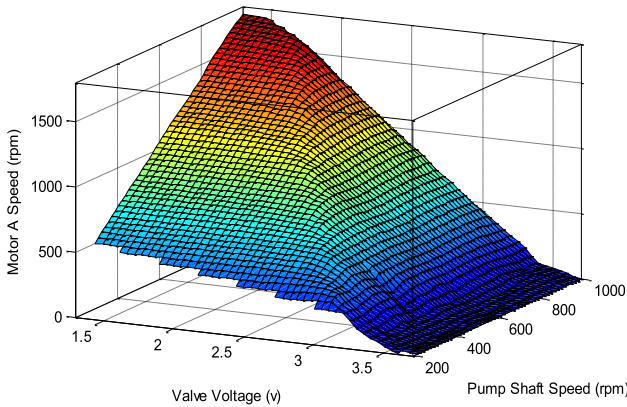

Fig. 5. Averaged steady-state response of the system in all operating points.

data in one region, and thus identifies one affine model for the entire system. This approach is the base for a dynamical system. The z -score method divides the observations into two partitions based on the empirical likelihood of the observation. Finally, k -means clustering aims to partition n observations into k clusters in which each observation belongs to the cluster with the nearest mean value. In addition, some advanced methods optimize the segmentation stage simultaneously with other system identification stages such as regressor estimation [22].

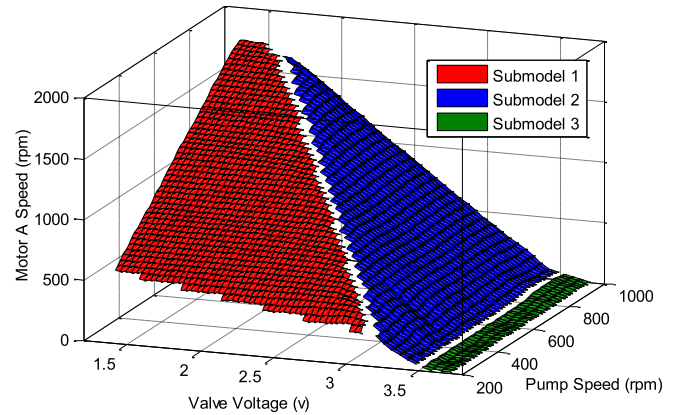

Fig. 6. All three submodels of the system derived from steady-state response.

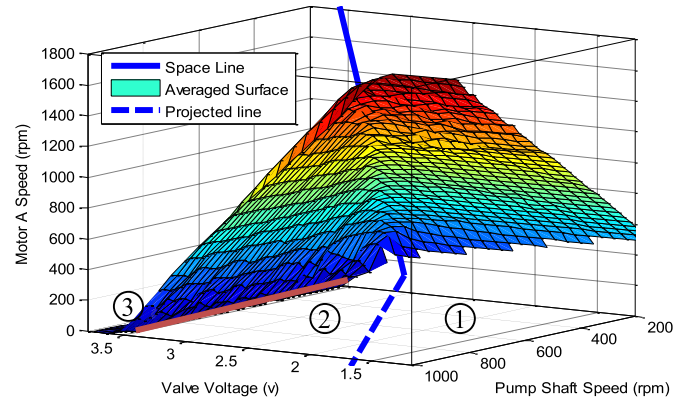

Fig. 7. Fitted space line and its projection on xy plane. All three clusters of the operating points.

For convenience, heuristic approach is employed in this paper based on system's steady-state response surface. Careful consideration of the averaged surface in Fig. 5, it can be concluded that three linear submodels can reasonably approximate the nonlinear system. This observation determines the number of discrete modes $s = 3$. Fig. 6 shows these submodels.

The next step is segmentation, which is looking for the coefficients $H_i = 1, \dots, s$, of the hyperplanes defining the partition of the regressor set. Averaged surface in Fig. 5 embodies a fracture, which can be described by a space line using two data points on a narrow band. Considering two operating points (2.95, 328, 489.5) and (1.8, 904, 1566), the space line equation can be derived as follows:

$$\begin{aligned} \text{Valve Voltage } (h_i) &= 1.25t + 1.75 \\ \text{Pump Speed } (\omega_p) &= -608t + 904 \\ \text{Motor A Speed } (\omega_{mA}) &= -1149t + 1572. \end{aligned} \quad (15)$$

Projection of this space line on the xy plane results in H_i coefficients, which is used for partitioning of submodels described as follows:

$$\omega_p = -486.41h_i + 1755.2. \quad (16)$$

Fig. 7 shows the fitted space line and its projection on the xy plane. In addition, the valve voltages higher than 3.5 V specify the third cluster, which is shown as red solid line in Fig. 7.

C. Regression

Studying the nonlinear mathematical model of the proposed hydraulic wind power system specifies the order of the submodels. This system contains five poles and three zeros, which determines $n_a = 5$ and $n_b = 4$.

Once the data (operating points) are segmented, the dynamics of each region of the observed data is estimated using least-square technique. Here, the aim is to classify the data points into clusters and to estimate an affine submodel for each cluster. Assuming that N data points (y_k, x_k) are given, with $y_k \in \mathbb{R}$ and $x_k \in \mathbb{R}^n$, $k = 1, \dots, N$, for a fixed s , the considered problem can be formulated as follows [46]:

$$\lambda_{ki} = \begin{cases} 1 & \text{if } x_k \in \chi_i \\ 0 & \text{otherwise} \end{cases} \quad k = 1, \dots, N, \quad i = 1, \dots, s$$

$$\min_{\theta_i} \frac{1}{N} \sum_{k=1}^N \sum_{i=1}^s (y_k - \phi_k' \theta_i)^2 \lambda_{ki}. \quad (17)$$

Solving (17) for θ_i s will result in submodels as follows:

$$\begin{aligned} \omega_{mA}(k) = & 0.3333\omega_{mA}(k-1) + 0.3333\omega_{mA}(k-2) \\ & + 0.3333\omega_{mA}(k-3) - 6.177\omega_{mA}(k-4) \\ & + 1.666\omega_{mA}(k-5) - 22.25h_i(k) \\ & + 7.417h_i(k-1) + 7.417h_i(k-2) \\ & + 7.417h_i(k-3) + 1.769\omega_p(k) \\ & - 0.5897\omega_p(k-1) - 0.5897\omega_p(k-2) \\ & - 0.5897\omega_p(k-3) \\ & \text{if } \omega_p \ll -486.41h_i + 1755.2 \\ \omega_{mA}(k) = & 0.3333\omega_{mA}(k-1) + 0.3333\omega_{mA}(k-2) \\ & + 0.3333\omega_{mA}(k-3) + 1.722\omega_{mA}(k-4) \\ & - 8.598\omega_{mA}(k-5) - 896h_i(k) \\ & + 298.7h_i(k-1) + 298.7h_i(k-2) \\ & + 298.7h_i(k-3) + 0.0178\omega_p(k) \\ & - 0.005933\omega_p(k-1) - 0.005933\omega_p(k-2) \\ & - 0.005933\omega_p(k-3) \\ & \text{if } \omega_p \geq -486.41h_i + 1755.2 \\ \omega_{mA}(k) = & 0 \quad \text{if } h_i \geq 3.5. \end{aligned} \quad (18)$$

D. Validation and Experimental Results

Obtaining submodels of the nonlinear system (18) and their region of operation, a PWA system with switching rule can be implemented. To verify the performance of the identified model, several experiments have been carried out using different input profiles at the experimental prototype. Then, the experimentally recorded input profiles were applied to the PWA system and the results were compared. Figs. 8–11 show the comparisons of the results. As the system had two input variables, four cases were considered. In case 1, a fixed valve voltage was applied. In case 2, a step valve voltage was considered. In case 3, a triangle valve voltage was applied, and in case 4, a sinusoidal valve voltage and a pump speed variation were applied to mimic the practical wind speed and valve voltage.

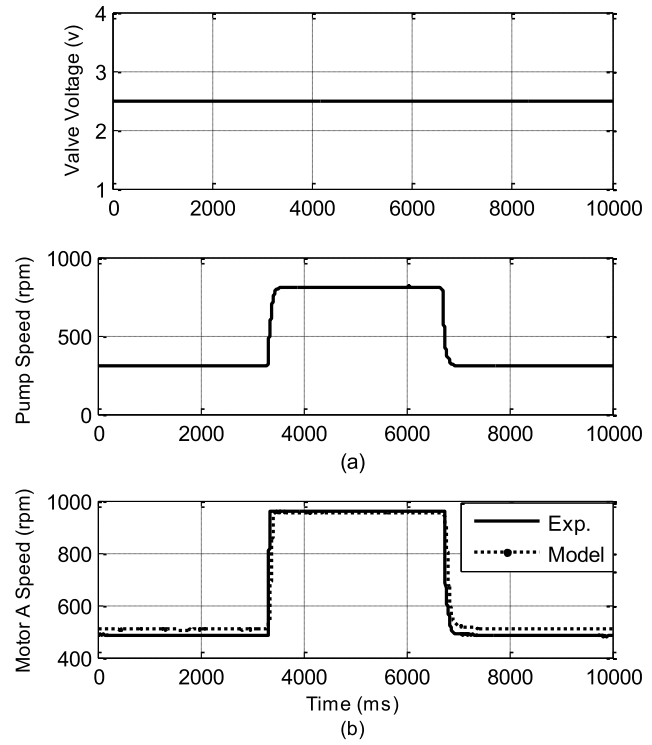

Fig. 8. (a) Inputs to the setup and model (constant, step). (b) Comparison of setup output and model.

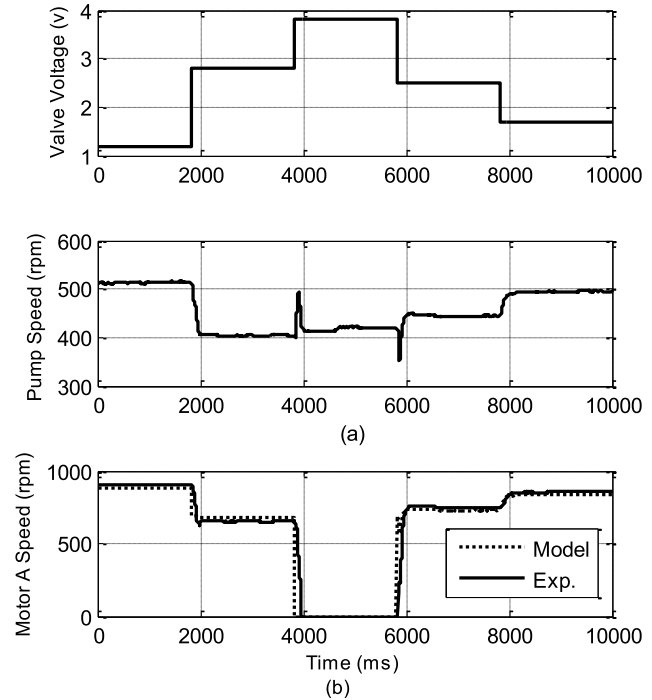

Fig. 9. (a) Inputs to the setup and model (step, step). (b) Comparison of setup output and model.

In Fig. 8(a), the valve position is fixed and a step pump speed disturbance is applied to the system. Fig. 8(b) shows the experimental and the model output. As it can be observed, piecewise linear model matched the experimental results accurately.

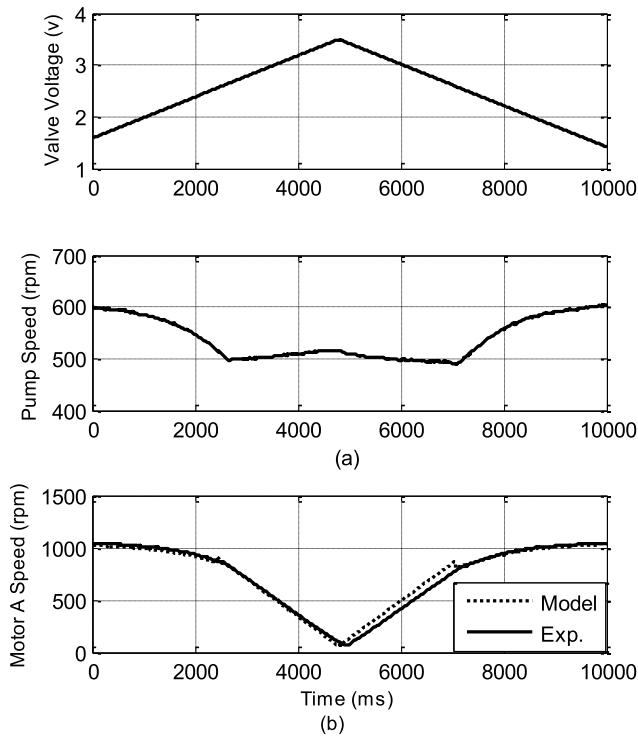

Fig. 10. (a) Inputs to the setup and model (ramp, ramp). (b) Comparison of setup output and model.

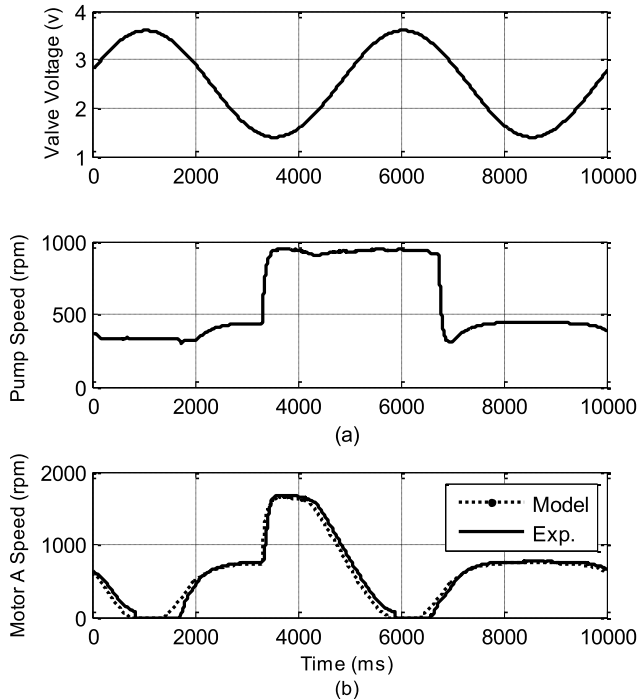

Fig. 11. (a) Inputs to the setup and model (sinusoidal, step). (b) Comparison of setup output and model.

For the second experiment (Fig. 9), a step valve position profile is applied to the system, which ranges from fully open to fully close. As the system load changed, the speed drop caused a slight speed drop at the pump. As it can

be demonstrated from the figure, the proposed model output matched the experiment at 92% accuracy.

To evaluate the effect of model averaging and analyze the performance of the proposed modeling, a triangle valve voltage was applied to the valve. The voltage uniformly increased from 1.5 to 3.5 V and then uniformly decreased to 1.5 V. Fig. 10 shows the valve input excitation voltage. In this case, the valve experienced an operation cycle as a gradual closing from fully open to fully closed and to fully open position. As a result [shown in Fig. 10(a)], the pump speed dropped from 600 to around 500 r/min, and then increased to 600 r/min. The motor A speed followed the same pattern and decreased from 1000 to 200 r/min, and then increased to 1000 r/min. The simulation results closely follow the experimental results and validate the approach taken to model the surfaces and the switching logic. A 93% match was observed from the mathematical modeling and experimental results. A slight deviation in the model output was observed when the valve started moving from fully closed position toward fully open.

Finally, in case 3, both input variables were strongly varying. Fig. 11 shows each of the applied inputs. A sinusoidal voltage variation for valve voltage command and step speed variations for wind turbine were considered. Output comparison of the experiment and the simulation shows a close match with an accuracy of 91%. Discrepancies occurred in transients were the result of nonideal affine parameter estimation.

It can be observed that the PWA system described a highly nonlinear dynamic of a hydraulic wind power transfer. The experimental results on different operating points and transients verified the mathematical modeling approach proposed through PWA systems. Figs. 8–11 show the accuracy of the model, which was above %91 match. The proposed piecewise system identification of the HWPTS validated the proposed approach to address the need for system modeling.

The actual HWPTSs employed more hydraulic components, which increased the nonlinearities and complicated the modeling procedure. However, due to the beneficial properties of system identification method, the proposed approach was generalized to the actual HWPTS.

VI. CONCLUSION

PWA system identification of a hydraulic wind power system was presented in this paper. Hysteresis in the proportional valve was compensated using averaging method on the response of the system on different operating points. A graphical approach of nonlinear system modeling was presented and found to be an effective modeling tool. Experimentally derived submodels described the nonlinear systems.

REFERENCES

- [1] A. Izadian, N. Girrens, and P. Khayyer, "Renewable energy policies: A brief review of the latest U.S. and E.U. policies," *IEEE Ind. Electron. Mag.*, vol. 7, no. 3, pp. 21–34, Sep. 2013.
- [2] S. Eriksson, H. Bernhoff, and M. Leijon, "Evaluation of different turbine concepts for wind power," *Renew. Sustain. Energy Rev.*, vol. 12, no. 5, pp. 1419–1434, 2008.
- [3] A. Izadian, "Central wind turbine power generation," U.S. Patent 8 878 384, Nov. 4, 2014.

- [4] S. Hamzehlouia, A. Izadian, A. Pusha, and S. Anwar, "Controls of hydraulic wind power transfer," in *Proc. 37th Annu. Conf. IEEE Ind. Electron. Soc. (IECON)*, Nov. 2011, pp. 2475–2480.
- [5] S. Hamzehlouia and A. Izadian, "Adaptive speed regulation of gearless wind energy transfer systems," in *Proc. 38th Annu. Conf. IEEE Ind. Electron. Soc. (IECON)*, Oct. 2012, pp. 2162–2167.
- [6] M. Vaezi, A. Izadian, and M. Deldar, "A model linearization technique for hydraulic wind power systems," in *Proc. Power Energy Conf. Illinois (PECI)*, Feb./Mar. 2014, pp. 1–5.
- [7] S. Casselman and L. Rodrigues, "A new methodology for piecewise affine models using Voronoi partitions," in *Proc. 48th IEEE Conf. Decision Control, 28th Chin. Control Conf. (CDC/CCC)*, Dec. 2009, pp. 3920–3925.
- [8] C. Y. Lai, C. Xiang, and T. H. Lee, "Identification and control of nonlinear systems using piecewise affine models," in *Proc. 11th Int. Conf. Control Autom. Robot. Vis. (ICARCV)*, Dec. 2010, pp. 2259–2265.
- [9] C. Wen, S. Wang, X. Jin, and X. Ma, "Identification of dynamic systems using piecewise-affine basis function models," *Automatica*, vol. 43, no. 10, pp. 1824–1831, 2007.
- [10] S. Suntharasantic, P. Rungtweesuk, and M. Wongsaisuwan, "Piecewise affine model approximation for unmanned bicycle," in *Proc. SICE Annu. Conf. (SICE)*, Sep. 2011, pp. 1063–1068.
- [11] H. Nakada, K. Takaba, and T. Katayama, "Identification of piecewise affine systems based on statistical clustering technique," *Automatica*, vol. 41, no. 5, pp. 905–913, 2005.
- [12] M. Vaezi and A. Izadian, "Multiple-model adaptive estimation of a hydraulic wind power system," in *Proc. 39th Annu. Conf. IEEE Ind. Electron. Soc. (IECON)*, Nov. 2013, pp. 2111–2116.
- [13] S. F. Asl, M. Athans, and A. Pascoal, "Estimation and identification of mass-spring-dashpot systems using multiple-model adaptive algorithms," in *Proc. ASME Int. Mech. Eng. Congr. Expo.*, 2002, pp. 499–506.
- [14] A. Izadian, P. Khayyer, and P. Famouri, "Fault diagnosis of time-varying parameter systems with application in MEMS LCRs," *IEEE Trans. Ind. Electron.*, vol. 56, no. 4, pp. 973–978, Apr. 2009.
- [15] A. Edalatnoor, A. Izadian, and M. Vaezi, "Indirect adaptive control of droplet dispensing in digital microfluidic systems," in *Proc. 39th Annu. Conf. IEEE Ind. Electron. Soc. (IECON)*, Nov. 2013, pp. 3580–3585.
- [16] M. Vaezi, A. Izadian, and M. Deldar, "Adaptive control of a hydraulic wind power system using multiple models," in *Proc. 40th Annu. Conf. IEEE Ind. Electron. Soc. (IECON)*, 2014.
- [17] L. Rodrigues and J. P. How, "Automated control design for a piecewise-affine approximation of a class of nonlinear systems," in *Proc. Amer. Control Conf.*, 2001, pp. 3189–3194.
- [18] H. E. S. Jazeh, M. Vaezi, F. C. Samavati, and S. A. A. Moosavian, "The robustness analysis of two motion control algorithms for Stäubli TX40 robot in object manipulation task," in *Proc. Int. Conf. Mechatronics Autom. (ICMA)*, Aug. 2011, pp. 2165–2170.
- [19] J. Thomas, S. Oлару, J. Buisson, and D. Dumur, "Robust model predictive control for piecewise affine systems subject to bounded disturbances," in *Proc. 2nd IFAC Conf. Anal. Design Hybrid Syst.*, 2006, pp. 329–334.
- [20] M. Athans *et al.*, "The stochastic control of the F-8C aircraft using a multiple model adaptive control (MMAC) method—Part I: Equilibrium flight," *IEEE Trans. Autom. Control*, vol. 22, no. 5, pp. 768–780, Oct. 1977.
- [21] A. Banerjee, Y. Arkun, B. Ogunnaiké, and R. Pearson, "Estimation of nonlinear systems using linear multiple models," *AICHE J.*, vol. 43, no. 5, pp. 1204–1226, 1997.
- [22] A. D. Buchan, D. W. Haldane, and R. S. Fearing, "Automatic identification of dynamic piecewise affine models for a running robot," in *Proc. IEEE/RSJ Int. Conf. Intell. Robots Syst. (IROS)*, Nov. 2013, pp. 5600–5607.
- [23] S. Hamzehlouia and A. Izadian, "State-space representation of a hydraulic wind power transfer," in *Proc. IEEE Int. Conf. Electro/Inf. Technol. (EIT)*, May 2012, pp. 1–6.
- [24] A. Pusha, A. Izadian, S. Hamzehlouia, N. Girrens, and S. Anwar, "Modeling of gearless wind power transfer," in *Proc. 37th Annu. Conf. IEEE Ind. Electron. Soc. (IECON)*, Nov. 2011, pp. 3176–3179.
- [25] S. Hamzehlouia and A. Izadian, "Nonlinear state space model of a hydraulic wind power transfer," in *Proc. 38th Annu. Conf. IEEE Ind. Electron. Soc. (IECON)*, Oct. 2012, pp. 1098–1103.
- [26] S. Hamzehlouia and A. Izadian, "Modeling of hydraulic wind power transfers," in *Proc. IEEE Power Energy Conf. Illinois (PECI)*, Feb. 2012, pp. 1–6.
- [27] A. Izadian, S. Hamzehlouia, M. Deldar, and S. Anwar, "A hydraulic wind power transfer system: Operation and modeling," *IEEE Trans. Sustainable Energy*, vol. 5, no. 2, pp. 457–465, Apr. 2014.
- [28] M. Deldar, A. Izadian, and S. Anwar, "Modeling of a hydraulic wind power transfer system utilizing a proportional valve," in *Proc. IEEE Energy Convers. Congr. Expo. (ECCE)*, Sep. 2013, pp. 3311–3316.
- [29] Y.-Y. Chen, P.-Y. Huang, and J.-Y. Yen, "Frequency-domain identification algorithms for servo systems with friction," *IEEE Trans. Control Syst. Technol.*, vol. 10, no. 5, pp. 654–665, Sep. 2002.
- [30] M. Foo, S. K. Ooi, and E. Weyer, "System identification and control of the broken river," *IEEE Trans. Control Syst. Technol.*, vol. 22, no. 2, pp. 618–634, Mar. 2014.
- [31] F. Cheraghpour, M. Vaezi, H. E. S. Jazeh, and S. A. A. Moosavian, "Dynamic modeling and kinematic simulation of Stäubli TX40 robot using MATLAB/ADAMS co-simulation," in *Proc. IEEE Int. Conf. Mechatronics (ICM)*, Apr. 2011, pp. 386–391.
- [32] B. H. G. Barbosa, L. A. Aguirre, C. B. Martinez, and A. P. Braga, "Black and gray-box identification of a hydraulic pumping system," *IEEE Trans. Control Syst. Technol.*, vol. 19, no. 2, pp. 398–406, Mar. 2011.
- [33] G. van der Veen, J.-W. van Wingerden, and M. Verhaegen, "Global identification of wind turbines using a Hammerstein identification method," *IEEE Trans. Control Syst. Technol.*, vol. 21, no. 4, pp. 1471–1478, Jul. 2013.
- [34] I. Colak, H. Ibrahim Bulbul, and M. Sahin, "System identification and control of an wound rotor AC induction machine for wind turbine," in *Proc. Int. Conf. Renew. Energy Res. Appl. (ICRERA)*, Oct. 2013, pp. 1053–1057.
- [35] I. Houtzager, B. A. Kulscár, J.-W. van Wingerden, and M. Verhaegen, "System identification for the control of wind turbine systems," in *Proc. 3rd Conf. Sci. Making Torque Wind*, 2010.
- [36] I. F. Balaguer, S. V. Kanev, D. Tcherniak, and M. Rossetti, "System identification methods on Alstom ECO 100 wind turbine," in *Proc. 3rd Torque Conf.*, Crete, Greece, 2010.
- [37] K. Wu, Q. Zhang, and A. Hansen, "Modelling and identification of a hydrostatic transmission hardware-in-the-loop simulator," *Int. J. Vehicle Design*, vol. 34, no. 1, pp. 52–64, 2004.
- [38] H. E. Merritt, *Hydraulic Control Systems*. New York, NY, USA: Wiley, 1967.
- [39] J. F. Blackburn, *Fluid Power Control*. Cambridge, MA, USA: MIT Press, 1969.
- [40] S. H. Zak, *Systems and Control*. New York, NY, USA: Oxford Univ. Press, 2003.
- [41] E. D. Sontag, "Nonlinear regulation: The piecewise linear approach," *IEEE Trans. Autom. Control*, vol. 26, no. 2, pp. 346–358, Apr. 1981.
- [42] A. L. Juloski, W. P. M. H. Heemels, G. Ferrari-Trecate, R. Vidal, S. Paoletti, and J. H. G. Niessen, "Comparison of four procedures for the identification of hybrid systems," in *Hybrid Systems: Computation and Control*. Berlin, Germany: Springer-Verlag, 2005, pp. 354–369.
- [43] S. Paoletti, A. L. Juloski, G. Ferrari-Trecate, and R. Vidal, "Identification of hybrid systems a tutorial," *Eur. J. Control*, vol. 13, nos. 2–3, pp. 242–260, 2007.
- [44] W. P. M. H. Heemels, B. De Schutter, and A. Bemporad, "Equivalence of hybrid dynamical models," *Automatica*, vol. 37, no. 7, pp. 1085–1091, 2001.
- [45] B. De Schutter and T. J. van den Boom, "MPC for continuous piecewise-affine systems," *Syst. Control Lett.*, vol. 52, nos. 3–4, pp. 179–192, 2004.
- [46] S. Paoletti, "Identification of piecewise affine models," Ph.D. dissertation, Dept. Inf. Eng., Univ. Siena, Siena, Italy, 2004.
- [47] J. Roubal, P. Husek, and J. Stecha, "Linearization: Students forget the operating point," *IEEE Trans. Educ.*, vol. 53, no. 3, pp. 413–418, Aug. 2010.
- [48] B. Zhang, M. Hsu, and U. Dayal, "Harmonic average based clustering method and system," U.S. Patent 6584433 B1, Jun. 24, 2003.
- [49] V. Kathiresan and P. Sumathi, "An efficient clustering algorithm based on Z-score ranking method," in *Proc. Int. Conf. Comput. Commun. Inform. (ICCCI)*, Jan. 2012, pp. 1–4.
- [50] M. Yedla, S. R. Pathakota, and T. M. Srinivasa, "Enhancing K-means clustering algorithm with improved initial center," *Int. J. Comput. Sci. Inf. Technol.*, vol. 1, no. 2, pp. 121–125, 2010.



Masoud Vaezi received the B.Sc. degree in mechanical engineering from the K. N. Toosi University of Technology, Tehran, Iran, in 2012, and the M.Sc. degree in mechanical engineering from the Purdue School of Engineering and Technology, Indianapolis, IN, USA, in 2014.

He was a Research Assistant with the Energy Systems and Power Electronics Laboratory, Indianapolis. His current research interests include modeling, simulation, and control of integrated systems.



Afshin Izadian (S'04–M'09–SM'10) received the M.S. degree in electrical engineering from the Iran University of Science and Technology, Tehran, Iran, in 2002, and the Ph.D. degree in electrical engineering from West Virginia University, Morgantown, WV, USA, in 2008.

He was a Post-Doctoral Researcher with the University of California at Los Angeles, Los Angeles, CA, USA, in 2009. He joined the Purdue School of Engineering and Technology, Indianapolis, IN, USA, in 2009, as an Assistant Professor, where he is currently the Founder and Director of the Energy Systems and Power Electronics Laboratory. His current research interests include application of controls in energy systems, energy conversion, power electronics, and electric power systems.

Prof. Izadian is a Lifetime Member of the Eta Kappa Nu, the Tau Beta Pi, and the Sigma Xi.